

Standard Recliner Features:

- Premium high-density, high-resiliency foam seat cushion
- Semi-attached back cushion
- Tight seat cushion
- Articulating headrest
- LED backlit control panel with USB charging port
- Stainless steel cup holder with adjustable LED lighting
- Stainless steel footrest extension hides all mechanical linkages
- Quick ship delivery
- Lifetime warranty on frame
- Ten year warranty on mechanism
- Five year warranty on motor

Options:

- Two-tone contrast available
(First tone includes outer shell and arms.
Second tone includes headrest, back cushion, and seat cushion.)
- Stainless steel cup holder without LED lighting
- No cup holder
- Battery with one year warranty
- Extra firm seating option (Seat cushion, back cushion, and headrest)
- Headrest cover available

MEE-REC-ST

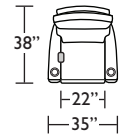

MEE-LVS-ST

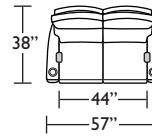

MEE-INS-06

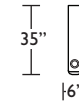

MEE-REC-LA

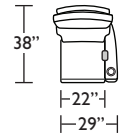

MEE-LVS-LA

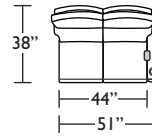

MEE-INS-09

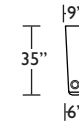

MEE-REC-RA

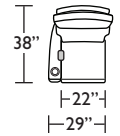

MEE-LVS-RA

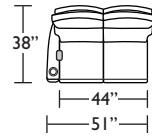

MEE-REC-AA

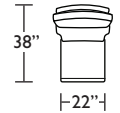

MEE-LVS-AA

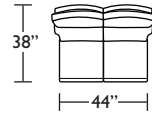

Important Note:

0 - This denotes power control box on arm

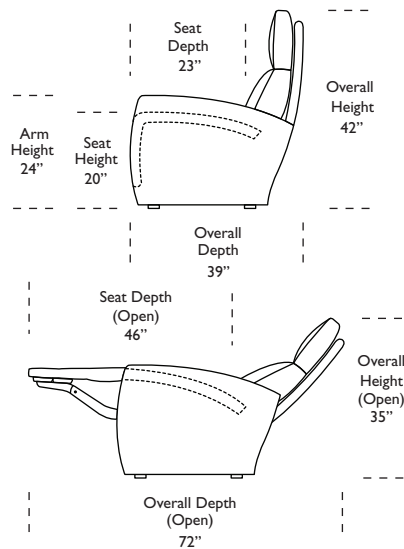

Note: Necessary Wall Clearance is 14"

U.S. Patent #8882190
Additional patents pending

Scale : 1/8 inch = 1 foot
All dimensions are approximate and subject to change.
Specify all components from the sitting position.

V05.18.16